

Kolpen

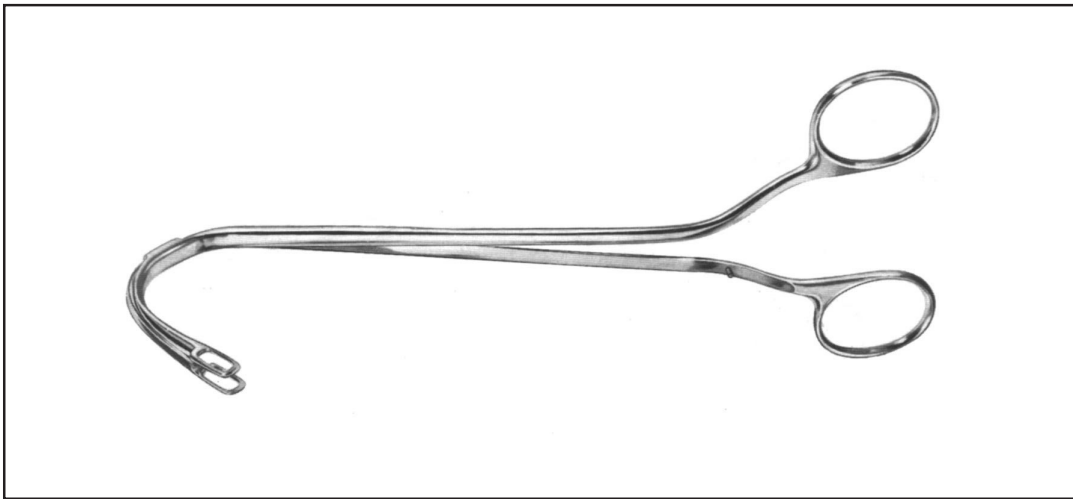

CA

Kolpen

Kidney Stone Forceps

LIVER, GALL BLADDER, KIDNEY
LEBER, GALLE, NIERE
HÍGADO, VESÍCULA BILIAR, RIÑÓN

NIERENSTEINZANGEN - PINZAS PARA CÁLCULOS RENALES

CA

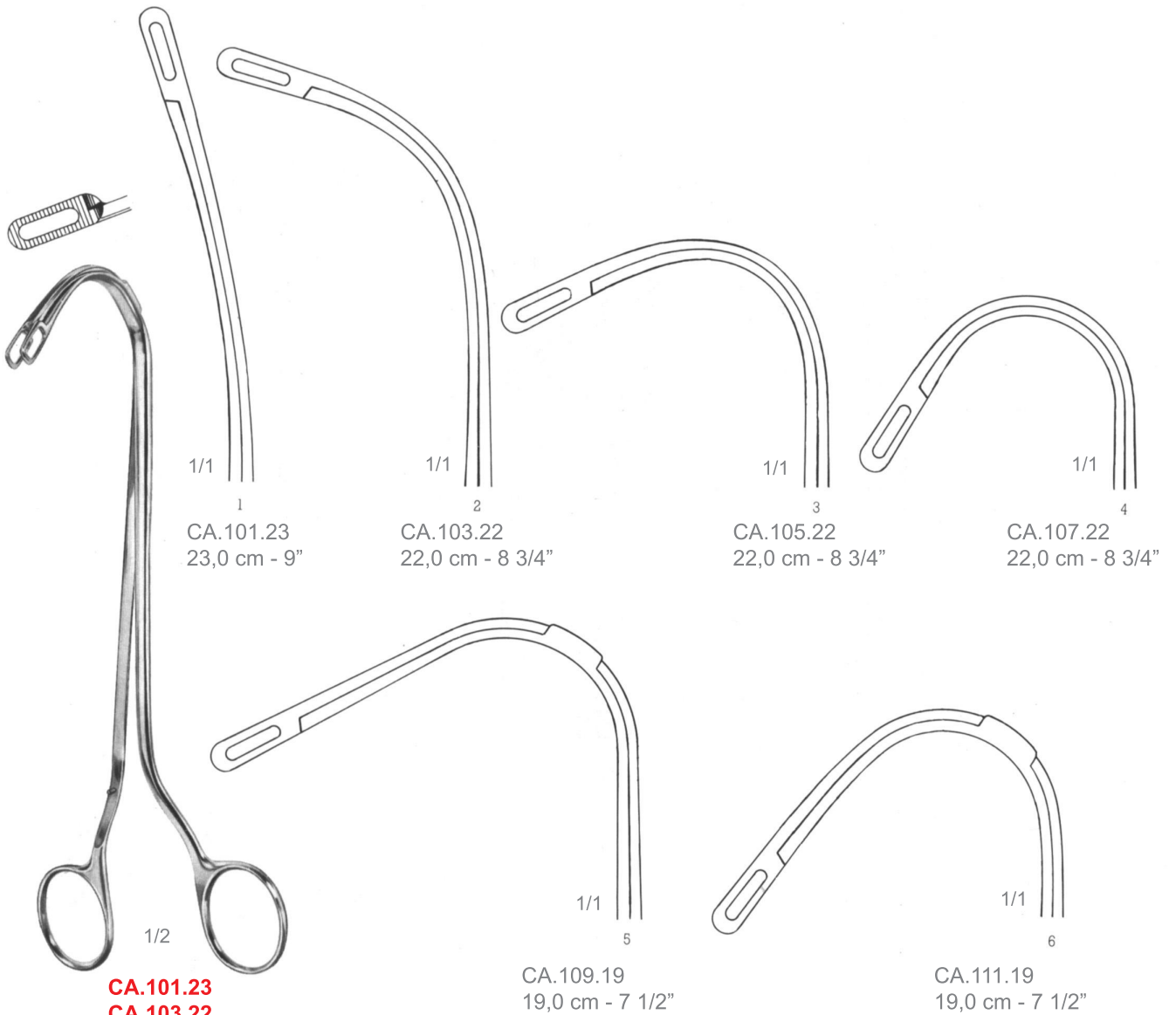
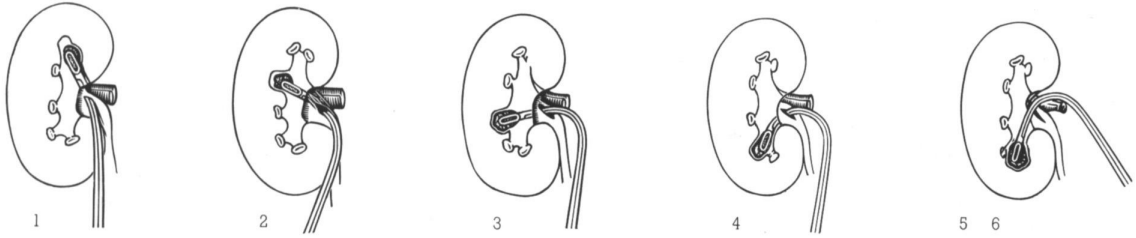

CA.101.23
CA.103.22
CA.105.22
CA.107.22
CA.109.19
CA.111.19

Randall
Kidney Stone Forceps

Kidney Stone Forceps

NIERENSTEINZANGEN - PINZAS PARA CÁLCULOS RENALES

Kolpen

LIVER, GALL BLADDER, KIDNEY
LEBER, GALLE, NIERE
HÍGADO, VESÍCULA BILIAR, RIÑÓN

CA

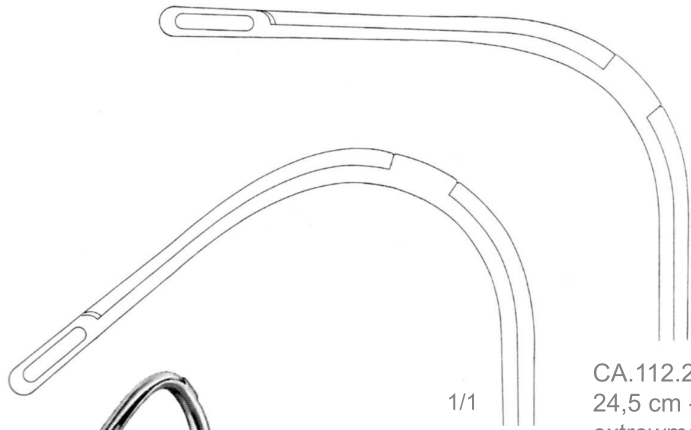

1/1

CA.112.24
24,5 cm - 9 3/4"
extremwely
delicated
pattern

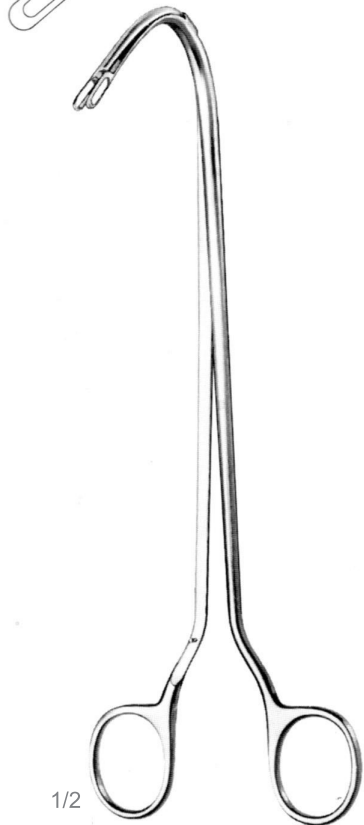

1/2

CA.112.23/24
Randall
Kidney Stone Forceps

CA.112.23
23,0 cm - 9"
extremwely
delicated
pattern

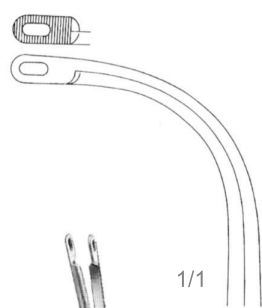

1/1

CA.113.16
16,0 cm - 6 1/4"
for children

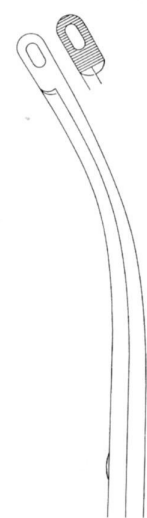

CA.113.17
17,0 cm - 6 3/4"
for children

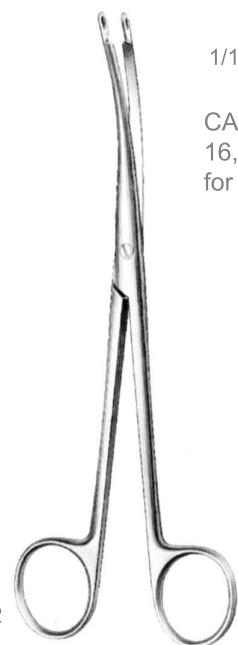

1/2

CA.113.16/17
Heiming
Kidney Stone Forceps

Kolpen

LIVER, GALL BLADDER, KIDNEY
LEBER, GALLE, NIERE
HÍGADO, VESÍCULA BILIAR, RIÑÓN

Kidney Forceps, Catheter Introducers

NIERENFABZANGEN, KATHETERFÜHRER - PINZA PARA RIÑÓN,
INTRODUCTOR DE CATÉTERES

CA



CA.112.26
26,5 cm - 10 1/2"

CA.112.26
Kocher
Kidney Forceps,
Catheter Introducers

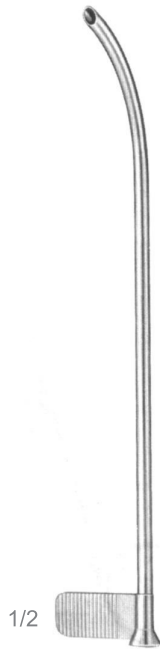

CA.113.18
18,0 cm - 7"
Catheter Introducer

CA.113.18
Hirth
Kidney Forceps,
Catheter Introducers

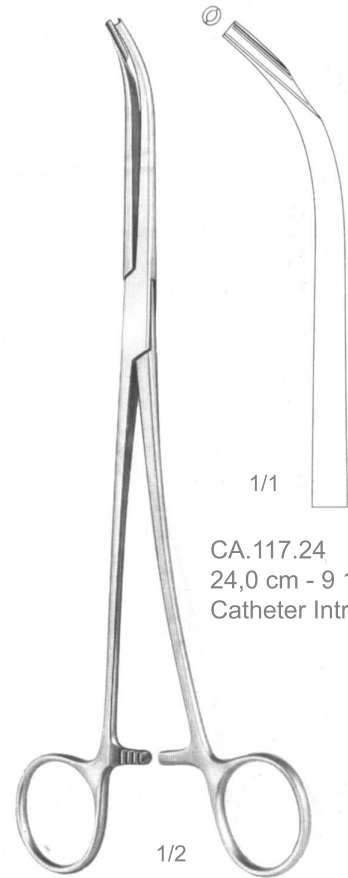

CA.117.24
24,0 cm - 9 1/2"
Catheter Introducer

CA.117.24
Sökeland
Kidney Forceps,
Catheter Introducers

Nephrostomy Forceps

NIERENFISTELZANGEN - PINZA PARA NEFROSTOMÍA

Kolpen

LIVER, GALL BLADDER, KIDNEY
LEBER, GALLE, NIERE
HÍGADO, VESÍCULA BILIAR, RIÑÓN

CA

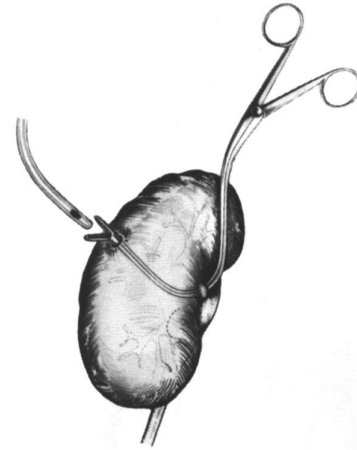

CA.115.01
20,0 cm - 8"

CA.115.01
Elsässer
Nephrostomy Forceps



CA.115.02
20,0 cm - 8"

CA.115.02
Elsässer
Nephrostomy Forceps

CA

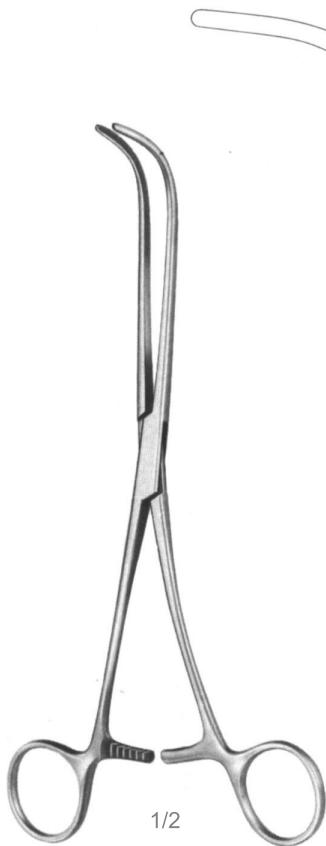
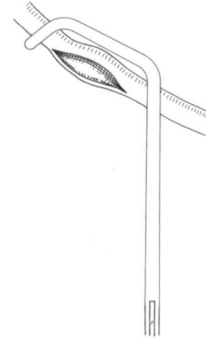
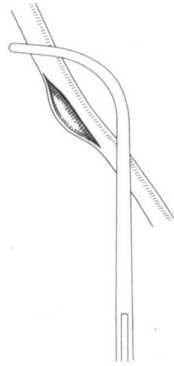

1/1

CA.119.01
21,0 cm - 8 1/4"

1/2

CA.119.01
Lurz
Ureter Calculus
Forceps

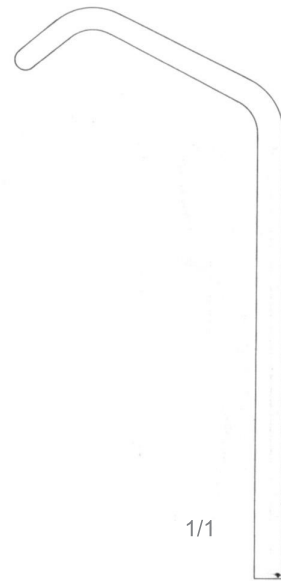
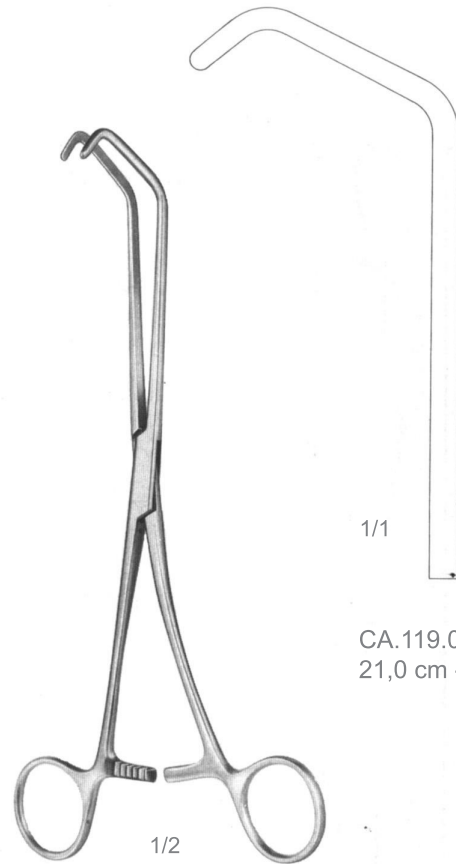

1/1

CA.119.02
21,0 cm - 8 1/4"

1/2

CA.119.02
Lurz
Ureter Calculus
Forceps

Gall Stone Probes, Gall Duct Dilators

GALLENSTEINSONDEN, GALLENKANAL-DILATOREN
 EXPLORADORES PARA CÁLCULOS BILIARES, DILATADORES PARA CONDUCTOS
 BILIARES

Kolpen

LIVER, GALL BLADDER, KIDNEY
 LEBER, GALLE, NIERE
 HÍGADO, VESÍCULA BILIAR, RIÑÓN

CA

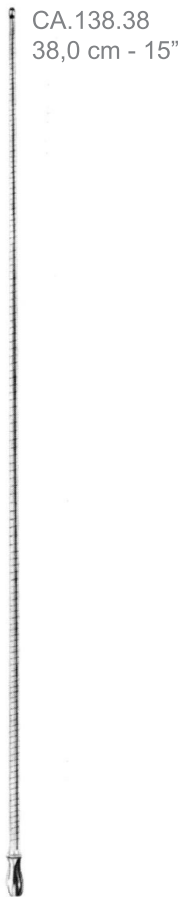

CA.138.38
 38,0 cm - 15"

CA.138.38
 Ochsner
 Gall Stone Probes
 Gall Duct Dilators

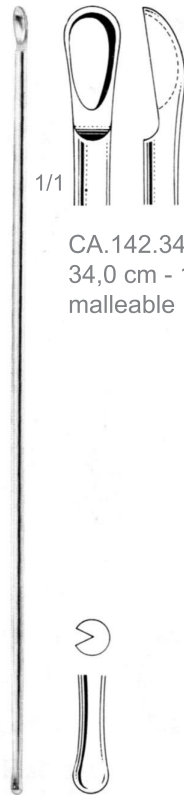

CA.142.34
 34,0 cm - 13 1/2"
 malleable

CA.142.34
 Moynihan
 Gall Stone Probes
 Gall Duct Dilators



CA.162.28
 28,0 cm - 11"
 elastic

CA.164.28
 28,0 cm - 11"
 elastic

CA.166.28
 28,0 cm - 11"
 elastic

CA.162.28
CA.166.28
 Desjardins
 Gall Stone Probes
 Gall Duct Dilators

Kolpen

LIVER, GALL BLADDER, KIDNEY
LEBER, GALLE, NIERE
HÍGADO, VESÍCULA BILIAR, RIÑÓN

Gall Stone Probes, Gall Duct Dilators

GALLENSTEINSONDEN, GALLENKANAL-DILATOREN
EXPLORADORES PARA CÁLCULOS BILIARES, DILATADORES PARA
CONDUCTOS BILIARES

CA



- CA.170.01 30,0 cm - 12"
 - CA.170.02 30,0 cm - 12"
 - CA.170.03 30,0 cm - 12"
 - CA.170.04 30,0 cm - 12"
 - CA.170.05 30,0 cm - 12"
 - CA.170.06 30,0 cm - 12"
 - CA.170.07 30,0 cm - 12"
 - CA.170.08 30,0 cm - 12"
 - CA.170.09 30,0 cm - 12"
 - CA.170.10 30,0 cm - 12"
 - CA.170.11 30,0 cm - 12"
 - CA.170.12 30,0 cm - 12"
 - CA.170.13 30,0 cm - 12"
- malleable shaft

1/2

CA.170.01/13
Bakes
Gall Stone Probes
Gall Duct Dilators

Gall Stone Forceps

GALLENSTEINZANGEN - PINZAS PARA CÁLCULOS BILIARES

Kolpen

LIVER, GALL BLADDER, KIDNEY
LEBER, GALLE, NIERE
HÍGADO, VESÍCULA BILIAR, RIÑÓN

CA

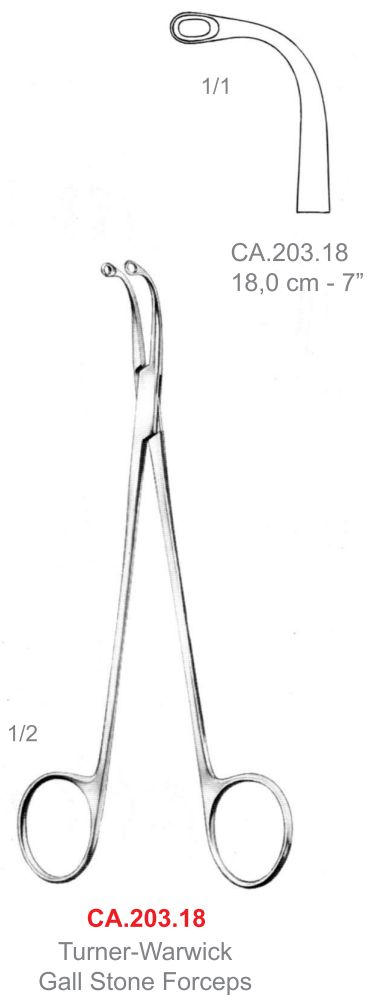

Kolpen

Gall Stone Forceps

LIVER, GALL BLADDER, KIDNEY
LEBER, GALLE, NIERE
HÍGADO, VESÍCULA BILIAR, RIÑÓN

GALLENSTEINZANGEN - PINZAS PARA CÁLCULOS BILIARES

CA

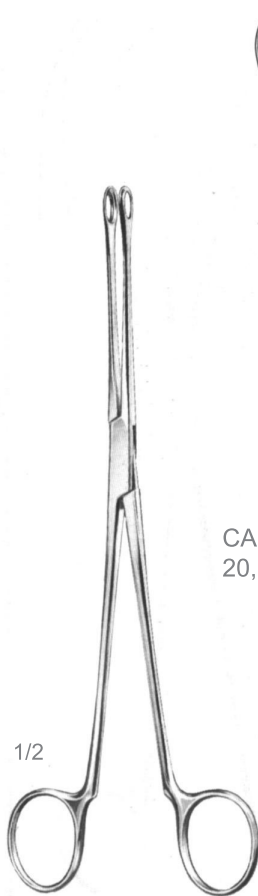

CA.204.20
20,0 cm - 8"

CA.205.20
20,0 cm - 8"

CA.204.20
CA.205.20
Blake
Gall Stone Forceps



CA.205.20
20,0 cm - 8"

CA.214.20
Mayo-Blake
Gall Stone Forceps



CA.215.20
20,0 cm - 8"

CA.215.20
Mayo-Blake
Gall Stone Forceps

Gall Stone Forceps, Catchers, and Scoops

GALLENSTEINZANGEN, GALLENSTEINFÄNGER -
 PINZAS, CUCHARILLAS Y CURETAS PARA COGER CÁLCULOS BILIARES

Kolpen

LIVER, GALL BLADDER, KIDNEY
 LEBER, GALLE, NIERE
 HÍGADO, VESÍCULA BILIAR, RIÑÓN

CA



CA.217.22
 22,0 cm - 8 3/4"

1/2

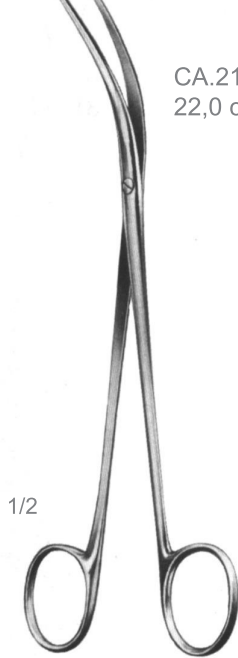

CA.217.22
 Mixer
 Gall Stone Forceps



CA.223.23
 23,0 cm - 9"

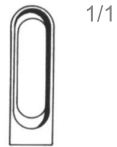

CA.225.23
 23,0 cm - 9"



1/2
CA.223.23
CA.225.23
 Desjardins
 Gall Stone Forceps

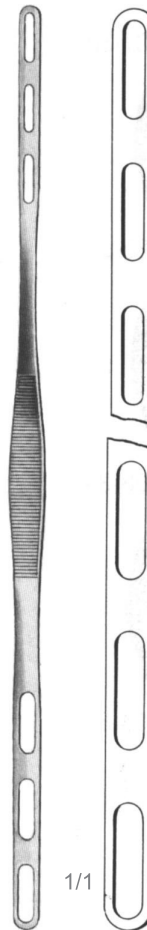

CA.320.27
 26,5 cm - 10 1/2"
 malleable

1/2

1/1

CA.320.27
 Gall Stone Forceps

Kolpen

LIVER, GALL BLADDER, KIDNEY
LEBER, GALLE, NIERE
HÍGADO, VESÍCULA BILIAR, RIÑÓN

Gall Stone Scoops

GALLENSTEINLÖFFEL - CUCHARILLAS PARA COGER CÁLCULOS BILIARES

CA

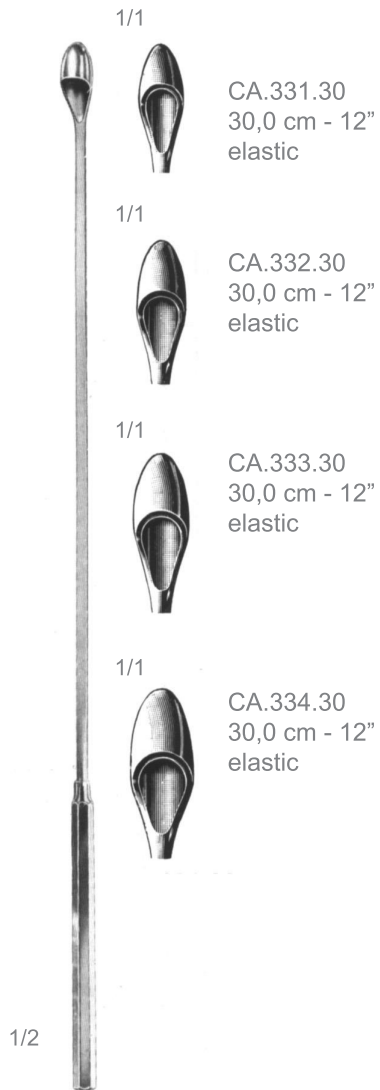

CA.331.30
CA.332.30
CA.333.30
CA.334.30
Desjardins
Gall Stone Scoops

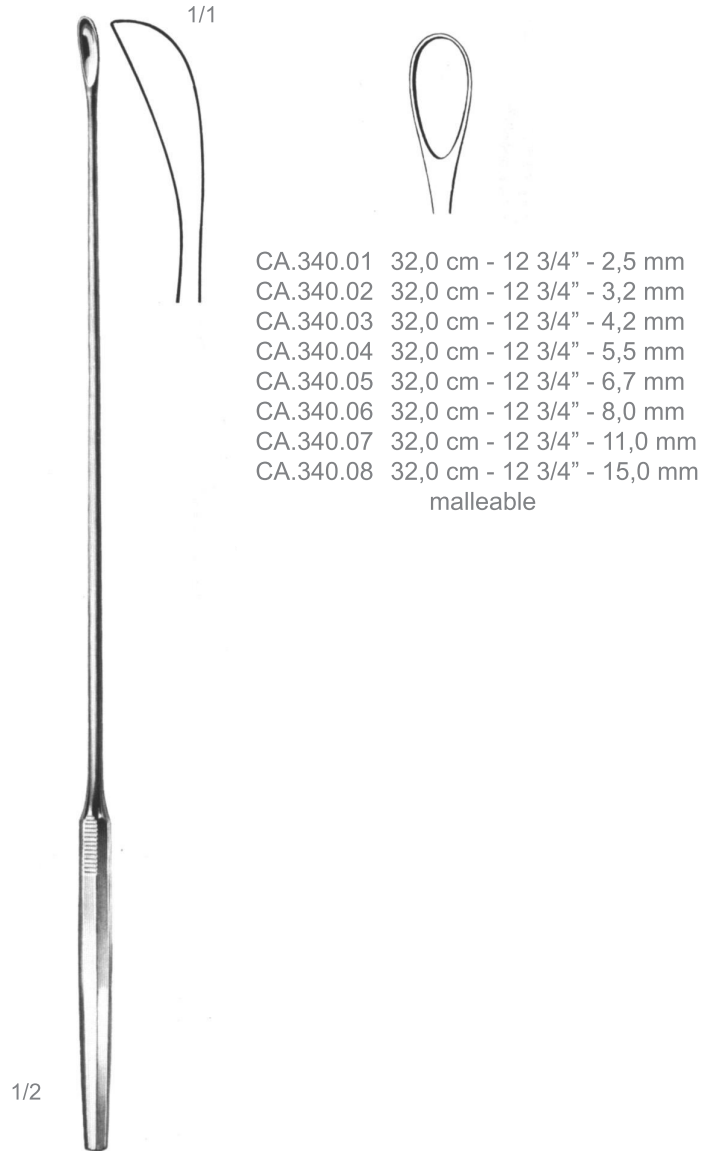

CA.340.01/08
Luer-Koerte
Gall Stone Scoops

CA.340.01	32,0 cm - 12 3/4" - 2,5 mm
CA.340.02	32,0 cm - 12 3/4" - 3,2 mm
CA.340.03	32,0 cm - 12 3/4" - 4,2 mm
CA.340.04	32,0 cm - 12 3/4" - 5,5 mm
CA.340.05	32,0 cm - 12 3/4" - 6,7 mm
CA.340.06	32,0 cm - 12 3/4" - 8,0 mm
CA.340.07	32,0 cm - 12 3/4" - 11,0 mm
CA.340.08	32,0 cm - 12 3/4" - 15,0 mm malleable

Gall Stone Scoops

GALLENSTEINLÖFFEL - CUCHARILLAS PARA COGER CÁLCULOS BILIARES

Kolpen

LIVER, GALL BLADDER, KIDNEY
LEBER, GALLE, NIERE
HÍGADO, VESÍCULA BILIAR, RIÑÓN

CA



CA.355.28
28,0 cm - 11"

1/2

CA.355.28
Moore
Gall Stone Scoops



CA.358.27
28,0 cm - 11"

CA.358.27
Mayo
Gall Stone Scoops



CA.361.34
34,0 cm - 12 1/2"

1/2

CA.361.34
Gall Stone Scoops



CA.362.21
21,5 cm - 8 1/2"

CA.362.22
22,0 cm - 8 3/4"

CA.362.23
23,5 cm - 9 1/4"

1/1

CA.362.21/23
Fergusson
Gall Stone Scoops



CA

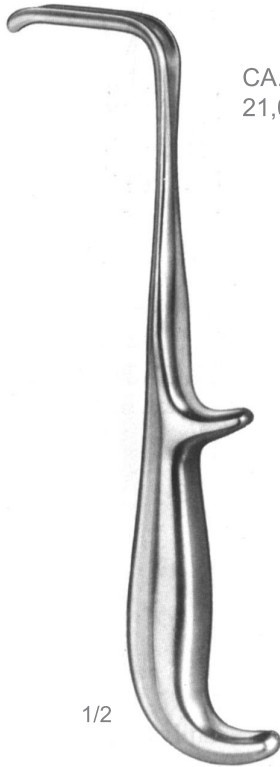
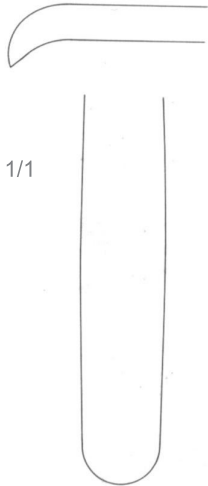

CA.401.21
21,0 cm - 8 1/4"

CA.401.21
Young
Prostatic Retractors

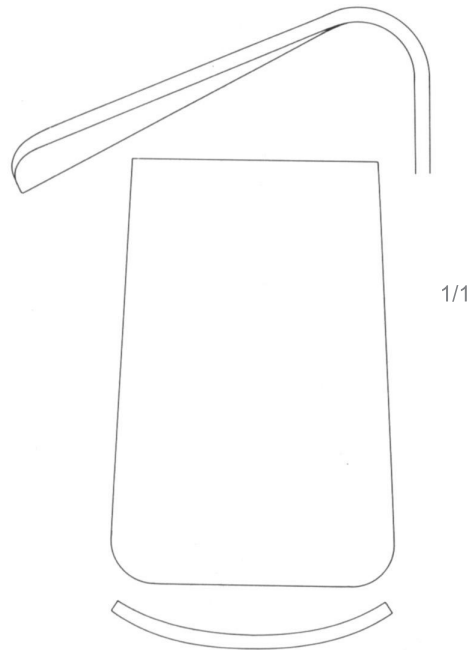

CA.403.22
22,0 cm - 8 3/4"

CA.403.22
Young
Prostatic Retractors

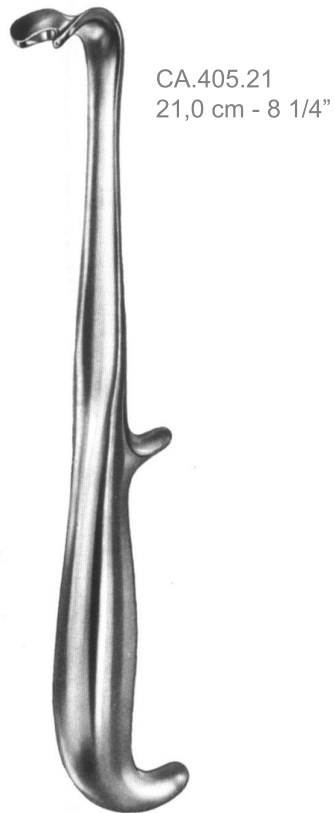
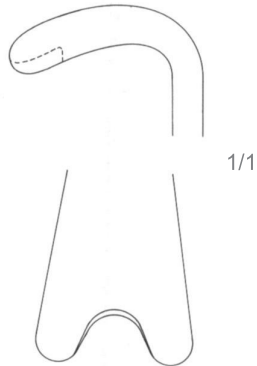

CA.405.21
21,0 cm - 8 1/4"

CA.405.21
Young
Prostatic Retractors

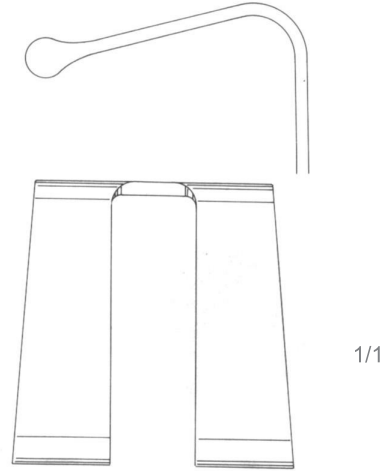

CA.407.22
22,0 cm - 8 3/4"

CA.407.22
Young
Prostatic Retractors

BLADDER, UROLOGY
BLASE, UROLOGIE
VEJIGA, UROLOGÍA

INSTRUMENTE FÜR PROSTATA-OPERATIONEN
INSTRUMENTOS PARA PROSTATECTOMÍA

CA



CA.451.24
23,5 cm - 9 1/4"
ATRAUMA

CA.451.24
Millin
Prostatectomy
Instruments

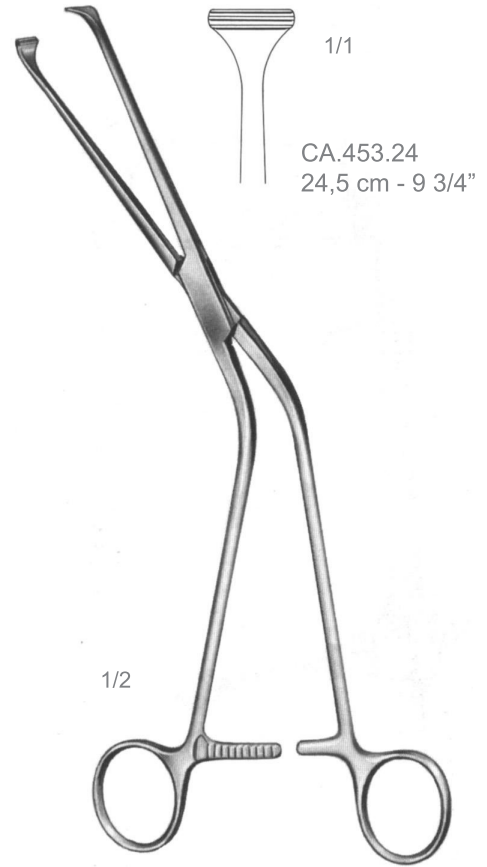

CA.453.24
24,5 cm - 9 3/4"

CA.453.24
Millin
Prostatectomy
Instruments



1/2

CA.461.23
CA.463.23
CA.465.24

Millin
Prostatectomy
Instruments

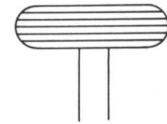

1/1

CA.461.23
23,0 cm - 9"



CA.463.23
23,0 cm - 9"

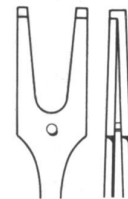

CA.465.24
24,0 cm - 9 1/2"

CA.451.24 - CA.453.24
CA.461.23
CA.463.23
CA.465.24

-Capsule Forceps
-Capsule Forceps, for retropubic prostatectomy
-Prostatic Lobe Holding Forceps, for anterior lobes, 9:9 teeth
-Ligature Carrying Forceps

CA

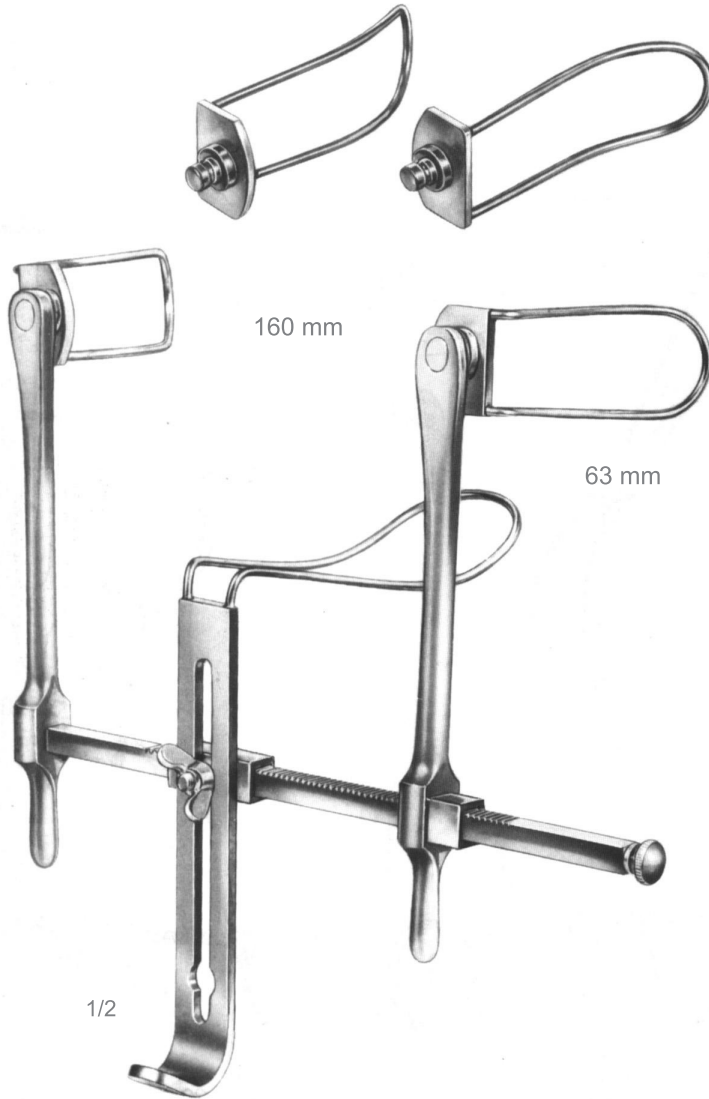

CA.470.00

Gosset
Bladder Retractors



CA.475.00

Millin
Bladder Retractors

CA.470.00
CA.475.00

-Bladder Retractor
-Meatus Clamp (Bladder Neck Spreader)



1/2

CA.503.00
Thomson-Walker
Bladder Retractors

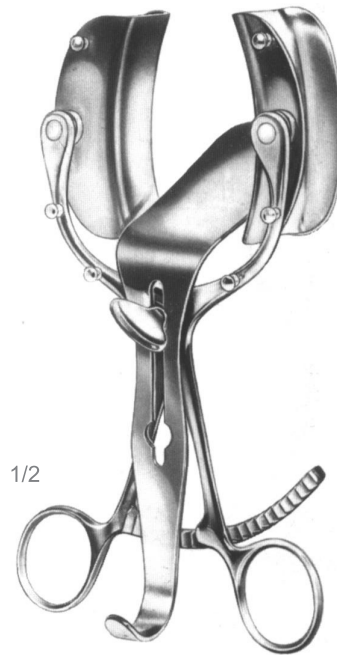

1/2

CA.508.00
Legueu
Bladder Retractors

CA

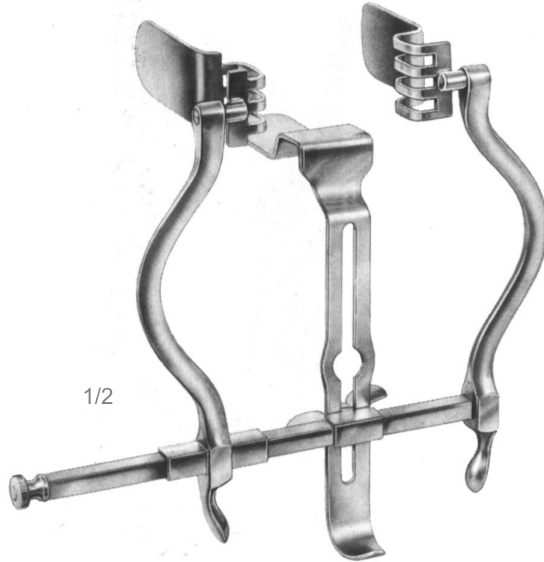

1/2

CA.510.00

Judd-Masson
Bladder Retractors

CA.512.00
2 Blades 57 mm x 25 mm
2 Blades 80 mm x 25 mm
1 Blade 120 mm x 45 mm

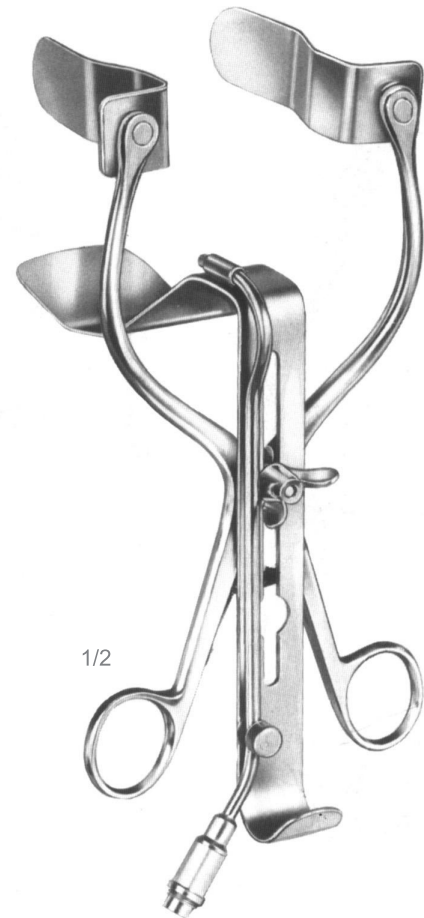
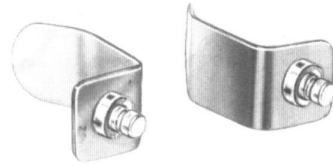

1/2

CA.512.00/51

CA.512.00	-without fiber optic
CA.512.50	-Centre valve with interchangeable fiber optic light carrier
CA.512.51	-fiber optic light carrier for CA.512.50



CA.527.27
35 mm

CA.527.27
27,0 cm - 10 1/2"

1/2

CA.527.27
Legueu
Bladder Retractors



CA.547.26
67 mm

CA.547.26
26,0 cm - 10 1/4"

1/2

CA.547.26
Kocher
Bladder Retractors

CA

Table of measurements

Scale I

Charrière (French) No. 8-36
rising by 1/3 mm per number

Scale II

Béniqué No. 20-26
rising by 1/3 mm per two
numbers

Scale	I	II	Dittel	van Buren	Guyon	Guyon
mm Ø	Charrière (French)	Béniqué		curved thread	without int. thread	with int.
2 2/3	8		CA.580.08	CA.599.08		
3	9		CA.580.09			
3 1/3	10	20	CA.580.10	CA.599.10	CA.605.10	CA.607.10
3 2/3	11	22	CA.580.11		CA.605.11	CA.607.11
4	12	24	CA.580.12	CA.599.12	CA.605.12	CA.607.12
4 1/3	13	26	CA.580.13		CA.605.13	CA.607.13
4 2/3	14	28	CA.580.14	CA.599.14	CA.605.14	CA.607.14
5	15	30	CA.580.15		CA.605.15	CA.607.15
5 1/3	16	32	CA.580.16	CA.599.16	CA.605.16	CA.607.16
5 2/3	17	34	CA.580.17		CA.605.17	CA.607.17
6	18	36	CA.580.18	CA.599.18	CA.605.18	CA.607.18
6 1/3	19	38	CA.580.19		CA.605.19	CA.607.19
6 2/3	20	40	CA.580.20	CA.599.20	CA.605.20	CA.607.20
7	21	42	CA.580.21		CA.605.21	CA.607.21
7 1/3	22	44	CA.580.22	CA.599.22	CA.605.22	CA.607.22
7 2/3	23	46	CA.580.23		CA.605.23	CA.607.23
8	24	48	CA.580.24	CA.599.24	CA.605.24	CA.607.24
8 1/3	25	50	CA.580.25		CA.605.25	CA.607.25
8 2/3	26	52	CA.580.26	CA.599.26	CA.605.26	CA.607.26
9	27	54	CA.580.27		CA.605.27	CA.607.27
9 1/3	28	56	CA.580.28	CA.599.28	CA.605.28	CA.607.28
9 2/3	29	58	CA.580.29		CA.605.29	CA.607.29
10	30	60	CA.580.30	CA.599.30	CA.605.30	CA.607.30
10 2/3	32			CA.599.32		
11 1/3	34			CA.599.34		
12	36			CA.599.36		
Set			CA.580.00	CA.599.00	CA.605.00	CA.607.00

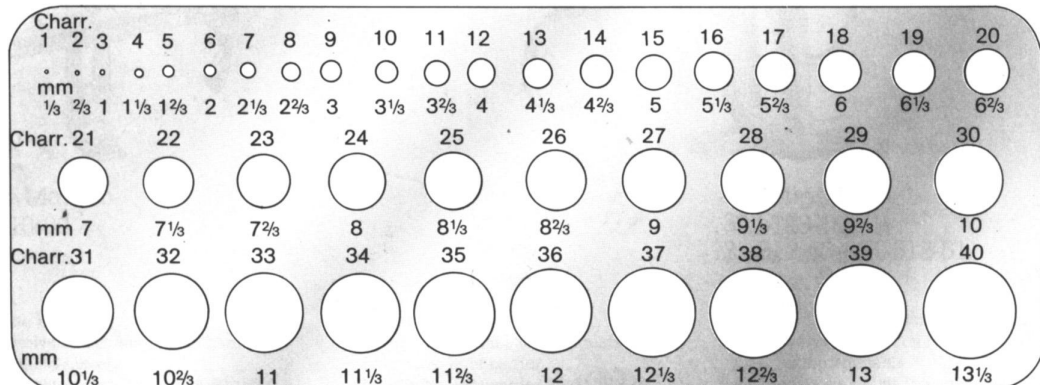

Dilating Bougies, Metal Catheters

DILATATIONSBOUGIES, METALL-KATHETER -
BUJÍAS DILATADORAS, SONDAS METÁLICAS

Kolpen

BLADDER, UROLOGY
BLASE, UROLOGIE
VEJIGA, UROLOGÍA

CA

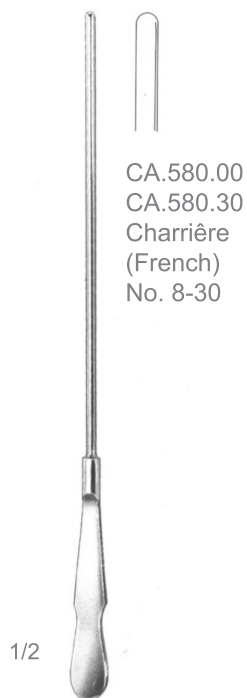

CA.580.00
CA.580.30
Charrière
(French)
No. 8-30

1/2

CA.580.00/30
Dittel
Dilating Bougies,
Metal Catheters

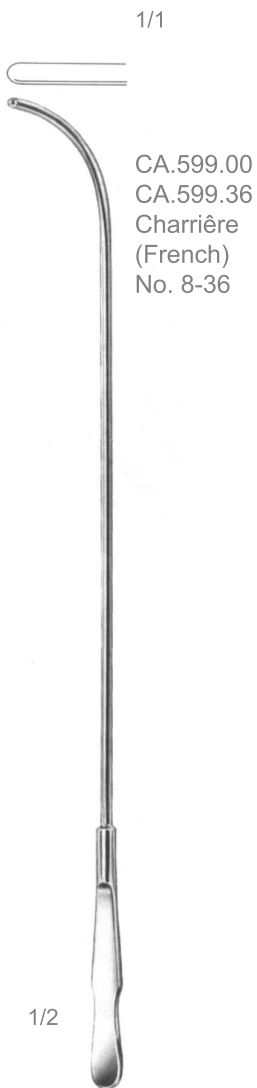

1/1
CA.599.00
CA.599.36
Charrière
(French)
No. 8-36

1/2

CA.599.00/36
van Buren
Dilating Bougies,
Metal Catheters

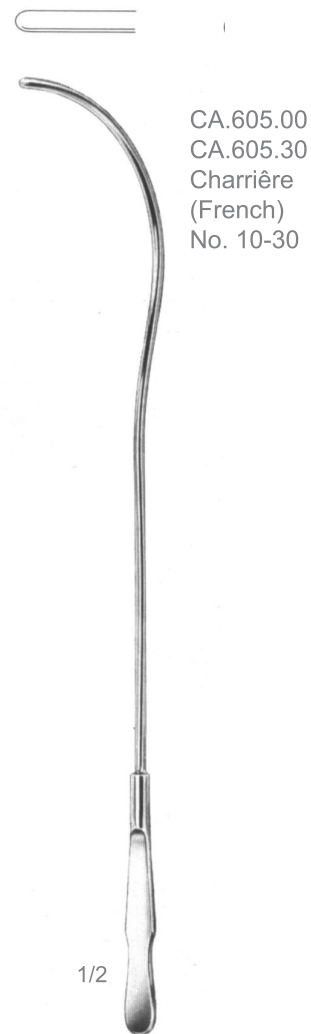

CA.605.00
CA.605.30
Charrière
(French)
No. 10-30

1/2

CA.605.00/30
Guyon
Dilating Bougies,
Metal Catheters

Kolpen

BLADDER, UROLOGY
BLASE, UROLOGIE
VEJIGA, UROLOGÍA

Dilating Bougies, Metal Catheters

DILATATIONSBOUGIES, METALL-KATHETER -
BUJÍAS DILATADORAS, SONDAS METÁLICAS

CA

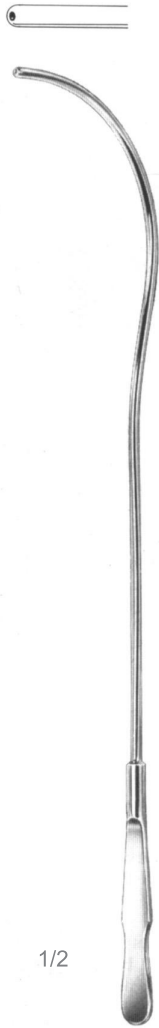

CA.607.00/30
Guyon
Dilating Bougies,
Metal Catheters

CA.607.00
CA.607.30
Charrière
(French)
No. 10-30

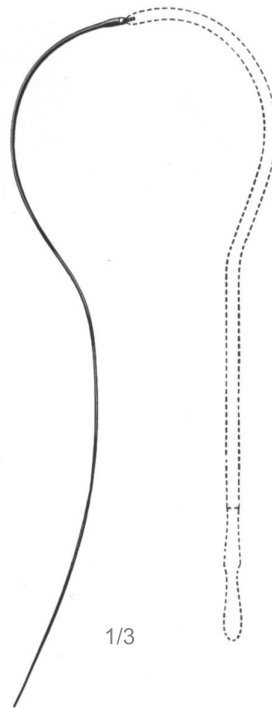

CA.610.12
Filiform
Dilating Bougies,
Metal Catheters



CA.721.06/24
Dilating Bougies,
Metal Catheters

CA.721.06 15 cm - 6"
CA.721.24 15 cm - 6"
Charrière (French)
No. 06-24

Set of Dilating Sounds

DILATATIONSBESTECK - JUEGO DE BUJÍAS DILATADORAS

Kolpen

BLADDER, UROLOGY
BLASE, UROLOGIE
VEJIGA, UROLOGÍA

CA

CA.612.00
420 x 175 x 40 mm



CA.612.00
Guyon
Set of Dilating
Sounds

CA.612.00 Set in metal case, containing:
21 Bougies, Guyon No. CA.617.10 - CA,617.30
6 liliform bougies CA.610.12 in metal tube

CA

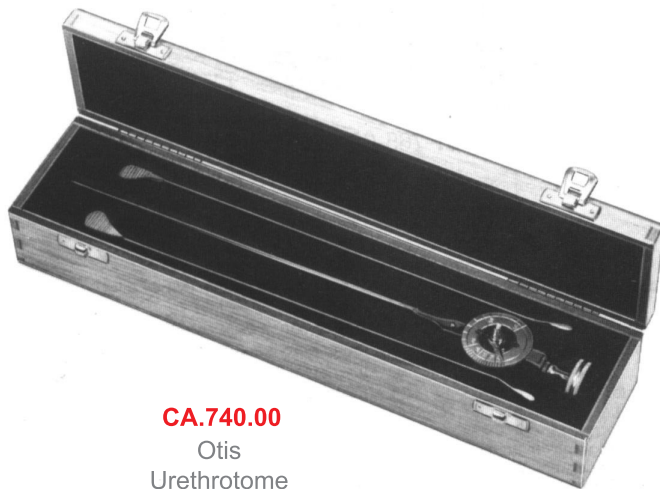

CA.740.00
Otis
Urethrotome

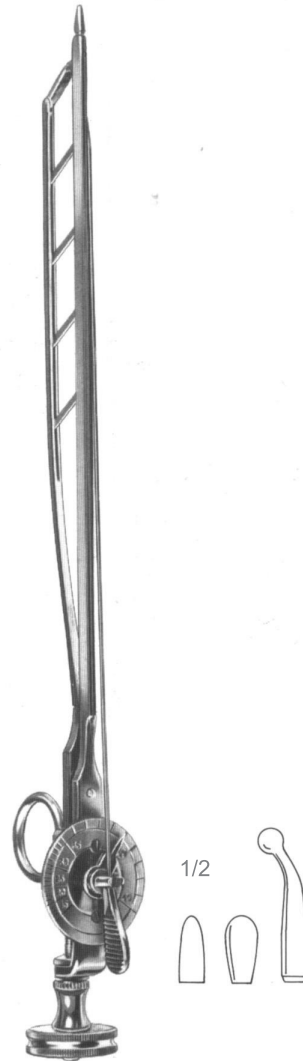

CA.745.00
Urethrotome

- | | |
|-----------|---|
| CA.740.00 | -Otis Urethrotome, in wooden case complete, consisting of:
1 Dilator
2 Blades
3 Tips |
| CA.745.00 | -Otis Spare Blade only |

Urethrotomes, Circumcision Instrument

URETHROTOME, BESCHNEIDUNGSINSTRUMENT
 URETRÓTOMOS, INSTRUMENTO DE CIRCUNCISIÓN

Kolpen

BLADDER, UROLOGY
 BLASE, UROLOGIE
 VEJIGA, UROLOGÍA

CA

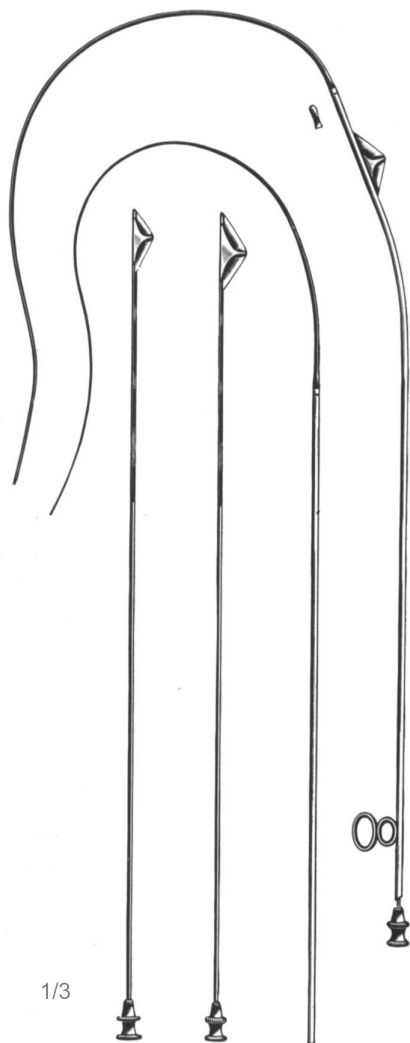

1/3

CA.755.00
CA.757.00

Urethrotomes,
 Circumcision Instrument

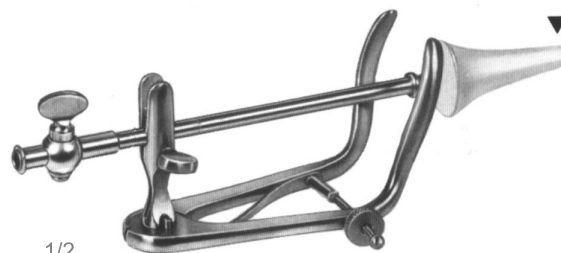

1/2

CA.760.00

Urethrotomes,
 Circumcision Instrument

CA.763.00

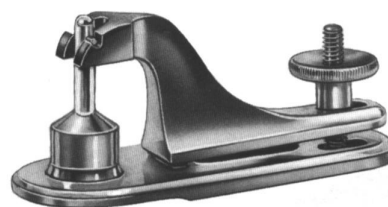

1/2

CA.765.08/32

Urethrotomes,
 Circumcision Instrument

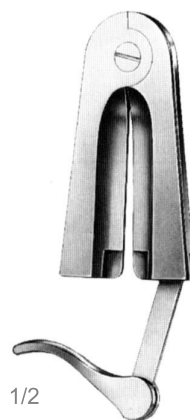

1/2

CA.766.00

Mogen
 Urethrotomes,
 Circumcision Instrument

CA.766.00 7,5 cm - 3"
 Circumcision Instrument

- CA.755.00 -Urethrotome, complete with 2 filiform guides, 1 stilette and 3 outward cutting blades
- CA.756.00 -ditto, but with 3 inward cutting blades
- CA.757.00 -Wood Case for CA.755.00 - CA.756.00
- CA.760.00 -Knutson Urethrography-Instrument consisting of holder, penile ad justable with sliding cannula with cone
 -Circumcision Instrument
- CA.765.08 -8 mm Ø, baby size
- CA.765.11 -11 mm Ø, child size
- CA.765.13 -13 mm Ø, child size
- CA.765.13 -13 mm Ø, child size
- CA.765.16 -16 mm Ø, adolescent size
- CA.765.21 -21 mm Ø, adolescent size
- CA.765.26 -26 mm Ø, men's size
- CA.765.32 -32 mm Ø, men's size

Kolpen

BLADDER, UROLOGY
BLASE, UROLOGIE
VEJIGA, UROLOGÍA

Catheter Introducing Instruments

KATHETER-EINFÜHRUNGSSINSTRUMENTE -
INSTRUMENTOS PARA INTRODUCIR CATÉTERES

CA

CA.785.46
46,0 cm -
18"



1/3

CA.785.46
Catheter Introducing
Instruments

CA.787.46
46,0 cm -
18"



1/3

CA.787.46
Catheter Introducing
Instruments



1/1

CA.792.39
39,0 cm -
15 1/2"



1/3

CA.792.39
CA.793.35
Catheter Introducing
Instruments

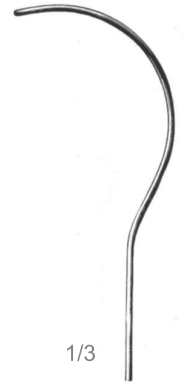

1/3

CA.793.35
35,0 cm -
13 3/4"

CA.785.46	-Mandrin for rubber catheter, with Dittel curve, adjustable cone
CA.787.46	-ditto, with Guyon curve
CA.792.39	-ditto, straight
CA.793.35	-ditto, curved

Meatotome, Secretion Scoops, Penis Seizing Forceps

MEATOTOM, SEKRETLÖFFEL, PENISKLEMMEN - MEATÓTOMO, CUCHARILLAS PARA SACAR SECRECIONES, COMPRESORES URETRALES

Kolpen

BLADDER, UROLOGY
BLASE, UROLOGIE
VEJIGA, UROLOGÍA

CA

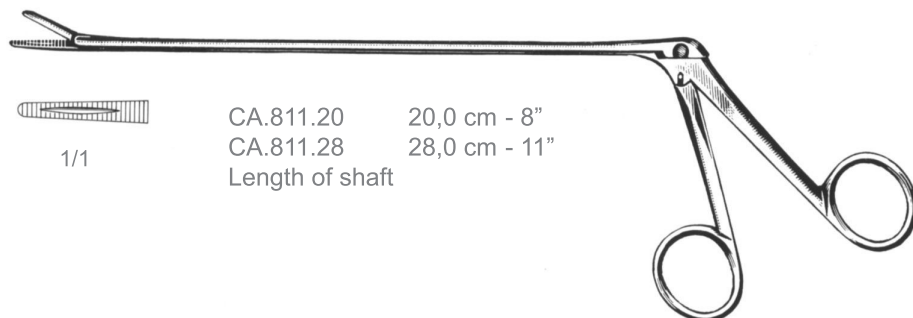

CA.811.20 20,0 cm - 8"
CA.811.28 28,0 cm - 11"
Length of shaft

CA.811.20/28
Mathieu
Meatotome, Secretion
Scoops, Penis Seizing
Forceps

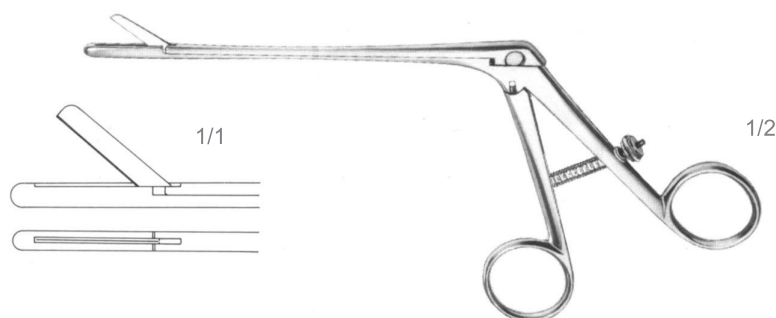

CA.817.12
Sachse
Meatotome, Secretion
Scoops, Penis Seizing
Forceps

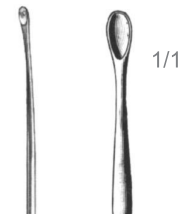

CA.840.26
Guttman
Meatotome, Secretion
Scoops, Penis Seizing
Forceps

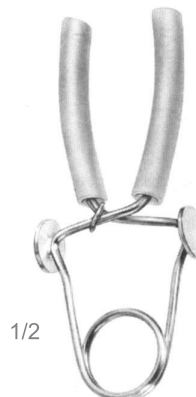

CA.881.11
Strauss
Meatotome, Secretion
Scoops, Penis Seizing
Forceps



CA.875.08
Stockmann
Meatotome, Secretion
Scoops, Penis Seizing
Forceps



CA.877.08
Stockmann
Meatotome, Secretion
Scoops, Penis Seizing
Forceps

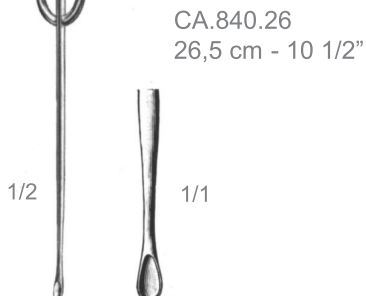

CA.817.12 | -Meatotome